

REVERSION	REVERSION RECORD	DATE	NAME
A	NEW DRAW	2019/1/12	Kang
B	UPDATE DRAW FORMAT	2021/7/2	ChenYJ
C	ADD TITLE L/F ROW COUNT, LEAD THICKNESS	2022/8/23	ChenYJ

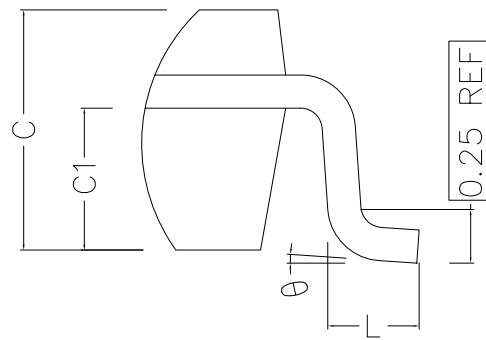
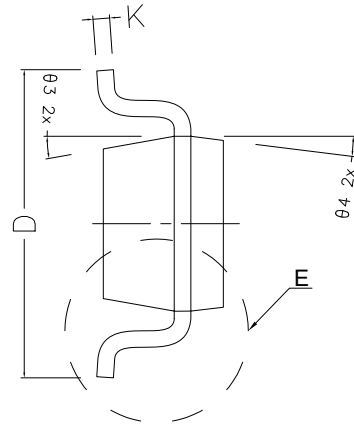
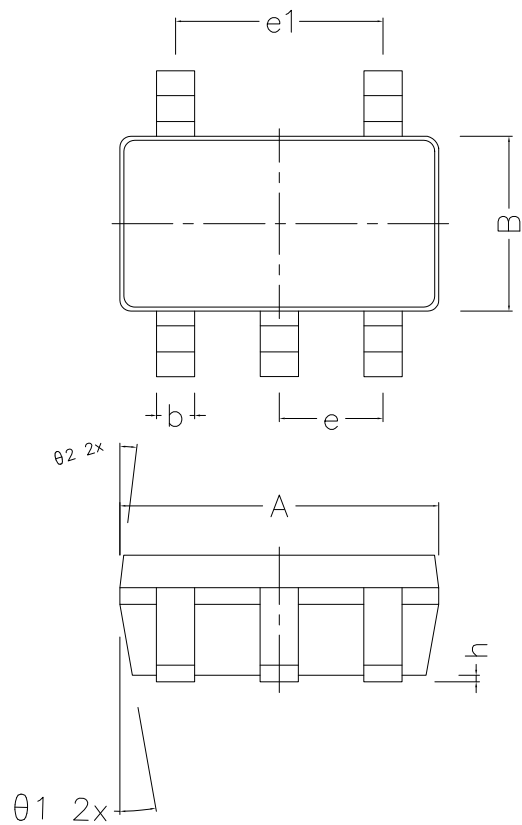

DETAIL E

COMMON DIMENSIONS
(UNITS OF MEASURE IS mm)

	MIN	NORMAL	MAX
A	2.820	2.920	3.020
B	1.500	1.600	1.700
C	1.050	1.100	1.150
C1	0.600	0.650	0.700
D	2.650	2.800	2.950
L	0.300	0.450	0.600
b	0.280	0.350	0.420
h	0.020	0.050	0.100
K	0.120	-	0.230
e	0.950TYPE		
e1	1.900TYPE		
theta1	10° TYPE		
theta2	7° TYPE		
theta3	10° TYPE		
theta4	7° TYPE		
theta	0° ~ 8°		



深圳市金誉半导体股份有限公司
SHENZHEN JINYU SEMICONDUCTOR CO.,LTD

 THIRD ANGLE PROJECTION				SCALE	1:1	UNIT	mm
TOLERANCE				APPROVALS		DATE	
0	0.0	0.00	0.000	DESIGNER	ChenYJ	2022.08.23	
				CHECKER	XieWH	2022.08.23	
				APPROVER	LinHB	2022.08.23	

SOT23-5L (10R12R)

DRG NO.	JY-POD-16	REV: C
FILE NO.	JY-RE-022-16	SHEET: 1 OF 1